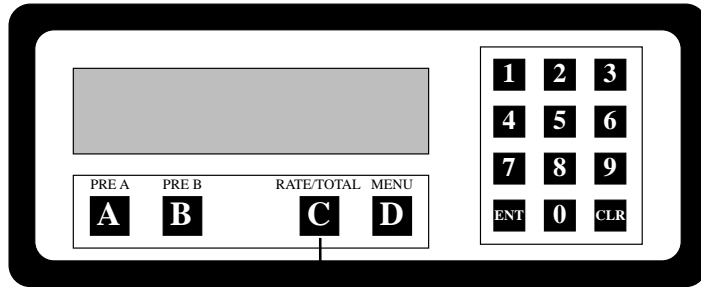

TABLE OF CONTENTS

APPLICATION	1
FEATURES	1
DESCRIPTION	1
WORKSHEET	2
SETTING PRESET A	3
SETTING PRESET B	3
SETTING THE COUNTER	3
SETTING THE RATEMETER	4
SETTING LOCKOUT CODE	4
SETTING THE COM. OUTCARD	5
SETTING RATE OR COUNT FOR ANALOG OUTPUT	6
SETTING OUTPUT PULSE FREQUENCY	6
SETTING RELAY FUNCTION & ON TIMES	7
VIEWING RATE, BATCH TOTAL, GRAND TOTAL	7
SETTING 16-POINT K-FACTOR	8
SPECIFICATIONS	9
TERMINATION	9
OPERATIONS	10
K-FACTOR	10
COUNTER	10
APPLICATION	11
MOUNTING DIMENSIONS	11
PULSE INPUTS	11
ANALOG INPUTS	11
SETTING K FACTOR FOR ANALOG INPUT	12
ANALOG INPUT EXCHANGE/CALIBRATION	12
RESET	12
FACTOR/"DATA LOST"/"RFFF"	12
PRESETS	13
RELAY OUTPUT TIMING	13
SCALED OUTPUT/DATA LOST	13
RATEMETER	13
SETTING RATE K-FACTOR FOR PULSE INPUT	13
LOCKOUT	14
REMOVING THE CASE	14
INPUT CARD MODIFICATION	14
OUTCARD RS232/RS422 SERIAL INTERFACE	14
RS232 ELECTRICAL REQUIREMENTS	14
RS422 ELECTRICAL REQUIREMENTS	15
RS232/RS422 SERIAL INPUT CODES	15
SERIAL INTERFACE OPERATION	15
STROBE ADDRESS OPERATION	16
STROBE INPUT ELECTRICAL REQUIREMENTS	16
232 WIRING	16
STROBE WIRING FOR RS232	16
RS422 INPUT WIRING	17
STROBE WIRING FOR RS422	17
ANALOG OUTPUT	17
OPTIONAL 16-POINT LINEARIZATION OF VARIABLE K-FACTOR	17
PART NUMBER BREAKDOWN	
WARRANTY	

APPLICATION

Batch control, cut to length, packaging, blending. The display may be toggled between total, rate, and grand total. Programmable K-factor makes keying - in engineering units easy. Unit accepts pulse, contact closures or analog input and provides two separate preset controls.



PRESS "C" TO SEE RATE

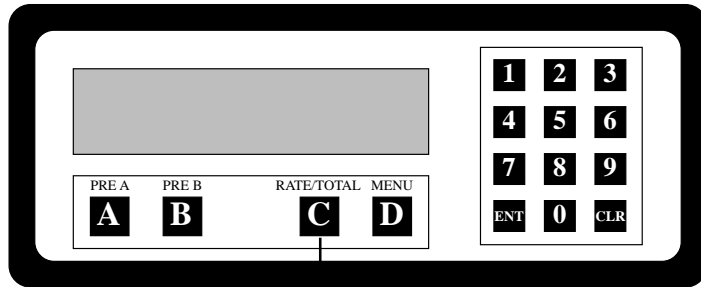

PRESS "C" AGAIN TO SEE BATCH TOTAL.

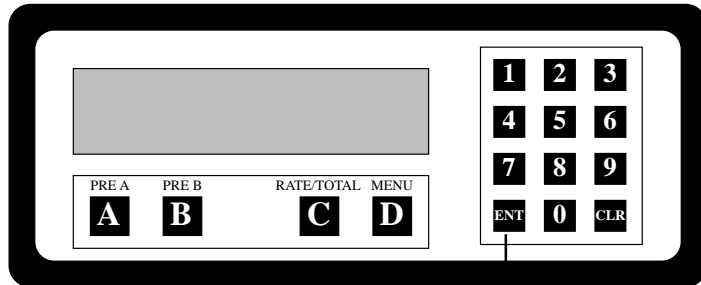

PRESS "ENT" TO SEE GRAND TOTAL

FEATURES

- * Pulse or Analog Input (with Totalizing Integration)
- * Display Total, Rate or Grand Total
- * 2 Presets - User Selectable for Total, Rate or Grand Total
- * Pulse Input to 20 KHz Count Frequency
- * 16 Point Linearization
- * K - Factor Programmable to 8 Places
- * Security Lockout
- * 2 way RS232/422/422M Communications
- * NEMA 4X Front Panel
- * Scaleable 4 - 20mA Output of Rate
- * Scaled Pulse Out, Frequency Selectable

DESCRIPTION

Featuring 8 digits of bright, .55", alphanumeric display, the pulse input version of the unit can accept up to 20,000 pulses per second. The analog input version accepts inputs, such as 4 to 20mA or 1 to 5V. It uses a highly linear integrator (V to F converter) to generate 0 to 10KHz digital pulses. The unit has two separate, 8 digit, floating decimal, "K" factors to convert the inputs to meaningful count and rate data. The user, with the push of a button, can toggle back and forth to view the total of the batch, the rate of flow and the grand total count.

Two controls outputs can be assigned independently by the user to activate at preset batch count, rate or grand total for .1 to 9.9 seconds or until reset externally.

A scaled pulse output is also provided by an open collector driver. Since the output frequency is user selectable at 10, 200, 2K or 20KHz, the unit can transmit the count data to electromechanical or electronic counters as well as computers, programmable controllers or other monitor equipment.

An optional analog 4 to 20mA output, selectable between rate or total, allows the user to select 4mA and 20mA rate settings to control strip chart recorders or other peripherals.

Up to 15 units can be connected to optional RS232 or RS422 communications port to set control points or access data. With RS422M up to 256 units can be linked together and addressed separately to transmit unit states or accept new set points. The Baud rate is "Auto Ranging" from 300 to 19.2K. It is also OPTOMUX Compatible.

WORKSHEET

MODEL # _____

SERIAL # _____

UNIT # _____



LOCKOUT CODE _____	
PR-LCK <input type="checkbox"/>	PR-UNLK <input type="checkbox"/>

COUNTER

K-FACTOR _____

Reset to 0

Set to Preset

DECimal LOCation (0-8)

8 7 6 5 4 3 2 1 0 none

RATEMETER

K-FACTOR _____

WINDOW (02-24) ____

SIGNificant FIGures (1-6) ____

WEIGHT (00-99) ____

AnaLoG OUTput RaTe CouNT

SET LOW rate 4mA _____

SET HIGH rate 20mA _____

OUT FREQUENCY

- 20000
- 2000
- 200
- 10

OUTCARD

UNIT (00-15) ____

ParalleL or SERIAL

(RS422M)

BAUDRATE

PARITY

- | | |
|-------------------------------|--------------------------------|
| <input type="checkbox"/> 300 | <input type="checkbox"/> SPACE |
| <input type="checkbox"/> 600 | <input type="checkbox"/> EVEN |
| <input type="checkbox"/> 1200 | <input type="checkbox"/> ODD |
| <input type="checkbox"/> 2400 | <input type="checkbox"/> MARK |
| <input type="checkbox"/> 4800 | |
| <input type="checkbox"/> 9600 | |

PRESET A _____

PRESET B _____

RELAY Open Collector

A TOTAL

A GRand TOTal

A RATE

DURation of A (0.0-9.9) ____ . ____

B TOTAL

B GRand TOTal

B RATE

DURation of B (0.0-9.9) ____ . ____

- 1- NOT USED
- 2- SCALED OUTPUT O.C.
- 3- ANALOG OUTPUT (SINK)
- 4- INPUT A (PULSE/ANALOG)
- 5- RESET INPUT
- 6- NOT USED
- 7- NOT USED
- 8- NOT USED
- 9- NOT USED
- 10- NOT USED
- 11- GROUND (-DC)
- 12- GROUND (-DC) INPUT COMMON
- 13- +12 VDC OUT
- 14- +DC POWER IN
- 15- ISOLATED -12VDC
- 16- ISOLATED +12VDC
- 17- AC IN
- 18- AC IN
- 19- PRESET B OPEN COLLECTOR
- 20- PRESET A OPEN COLLECTOR

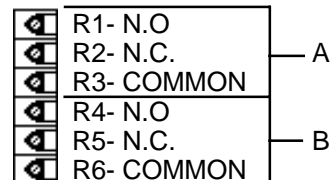

SETUP PROCEDURE

NOTE: Start here and finish to the end. If you make a mistake, press ENT until you reach the beginning.

STEP 1
SETTING PRESET A

PRESS

A (FINAL PRESET)

DISPLAY

PRESET A
THEN FLASHING PRESET #

CLR

0 FLASHES

1 2 3 4
(SAMPLE PRESET)

1 2 3 4 PRESET FLASHES

ENT

1 2 3 4 IS ENTERED

STEP 2
SETTING PRESET B

B (PREWARN)

PRESET B
THEN FLASHING PRESET #

CLR

0 FLASHES

1 2 0 0
(SAMPLE PREWARN)

1 2 0 0 PRESET FLASHES

ENT

1 2 0 0 IS ENTERED

STEP 3
SETTING THE COUNTER

D

MENU FLASHES TO **DEV TYP** ↓

ENT

RT ↓ **CNT** ↓ (RATE OR COUNT)

D (SET UP COUNTER)

K FACTOR FLASHES; THEN SHOWS
CURRENT K-FACTOR

CLR

0 FLASHES

1 D 2 7 8
(PRESS D FOR DECIMAL POINT)
K FACTOR IS DIVIDER. IT CONVERTS INPUT TO ENGINEERING UNITS.

1 . 2 7 8 FLASHES

ENT (K FACTOR ENTERED)

R0 ↓ **SP** ↓ (RESET TO 0 "ADD" OR SET TO
PRESET "SUBTRACT")

B OR **D**

SELECTS **R0** OR **SP**

ENT SELECTION ENTERED

DEC LOC (DECIMAL LOCATION)

PRESS ANY NUMBER

DECIMAL POINT MOVES TO THAT POSITION

ENT

LAST COUNT READING

STEP
4

**SETTING
THE
RATEMETER**

<u>PRESS</u>	<u>DISPLAY</u>
D	MENU FLASHES TO DEV TYP ↓
ENT	RT ↓ CNT ↓ (RATE OR COUNT)
B (SET UP RATEMETER)	K FACTOR FLASHES; THEN SHOWS CURRENT K-FACTOR
CLR	0 FLASHES
1 7 D 8 (PRESS D FOR DECIMAL POINT) K FACTOR IS DIVIDER. IT CONVERTS INPUT TO ENGINEERING UNITS.	1 7 . 8 FLASHES
ENT (K FACTOR ENTERED)	WINDOW ##
CLR	WINDOW 00
5 (AS AN EXAMPLE) (EXTENDS THE SAMPLING WINDOW TO 5 SECONDS)	WINDOW 05
ENT (WINDOW ENTERED)	SIG FIG ##
CLR	SIG FIG 00
6 (AS AN EXAMPLE) (SIG FIG INDICATES HOW MANY MEANINGFUL DIGITS ARE SHOWN TRAILING ZEROS ARE INSERTED IF NECESSARY)	SIG FIG 06
ENT (SIG FIG ENTERED)	WEIGHT ##
CLR	WEIGHT 0.0
9 9 (AS AN EXAMPLE) WEIGHT IS AN AVERAGING FACTOR. HIGHER SETTINGS PROVIDE MORE AVERAGING, FOR A MORE STABLE DISPLAY. DERIVED FROM: $\frac{\text{OLD DATA} \times \text{"WEIGHT"} + \text{NEW DATA}}{\text{"WEIGHT"} + 1}$	WEIGHT 9.9
ENT (WEIGHT ENTERED)	LAST COUNT READING

STEP
5

**SETTING
LOCKOUT
CODE**

	MENU FLASHES TO DEV TYP ↓
D	LOCKOUT ↓
ENT (LOCKOUT SELECTED)	CODE FLASHES; THEN SHOWS OLD CODE #.
CLR	0 FLASHES
1 1 1 1 (AS AN EXAMPLE)	1 1 1 1 FLASHES
ENT (CODE ENTERED)	PR LCK ↓ (LOCKOUT OF FRONT PANEL) PR UNLK ↓ (LOCKOUT OF ALL FRONT BUTTONS EXCEPT PRESETS A, B AND CLR)
ENT (LOCKOUT SELECTION ENTERED)	LAST COUNT READING
1 1 1 1	LOCK ON FLASHES (APPROPRIATE PANEL CHANGES LOCKED OUT)
1 1 1 1	LOCK OFF FLASHES (PANEL CHANGES ALLOWED)

STEP
6

**SETTING
THE COM.
OUT CARD**

**SKIP IF NOT
USED**

<u>PRESS</u>	<u>DISPLAY</u>
D	MENU FLASHES TO DEV TYP ↓
D	LOCKOUT ↓
D	OUTCARD ↓
ENT (OUTCARD SELECTED)	UNIT ##
CLR	UNIT 00
1 2 (AS AN EXAMPLE)	UNIT 12
ENT (UNIT LABELED 12)	PL ↓ SER ↓ *
ENT	BAUDRATE FLASHES THEN LAST BAUDRATE USED.
D	300 ↓
D	600 ↓
D	1200 ↓
D	2400 ↓
D	4800 ↓
D	9600 (PRESS D TO GO BACK TO 300)
ENT (PRESS AS DESIRED)	PARITY FLASHES THEN LAST PARITY SELECTED
D	EVEN ↓
D	ODD ↓
D	MARK ↓
D	SPACE ↓ (PRESS D TO GO BACK TO EVEN)
ENT (PRESS AS DESIRED)	LAST COUNT READING

*** UNIT ALWAYS SHOULD BE SER. PL IS DISABLED**

**STEP
7**

**SETTING
RATE OR
COUNT FOR
ANALOG
OUTPUT**

**SKIP IF NOT
USED**

PRESS	DISPLAY
D	MENU FLASHES TO DEV TYP ↓
D	LOCKOUT ↓
D	OUTCARD ↓
D	ALG OUT ↓
ENT (ANALOG SETUP SELECTED)	ANLG RT ↓ (4-20mA OUTPUT FOR RATE)
D (PRESS D TO TOGGLE BETWEEN SELECTIONS)	ANLG CT ↓ (4-20mA OUTPUT FOR COUNT)
ENT (ANLG RT OR ANLG CT SELECTED)	SET LOW FLASHES THEN CURRENT LOW SETTING
CLR	0 FLASHES
1 2 5 D 5 (PRESS D FOR DECIMAL POINT) AS AN EXAMPLE (IN THIS CASE 125.5 = 4mA)	1 2 5 . 5 FLASHES
ENT (LOW SET AT 125.5)	SET HIGH FLASHES THEN CURRENT HIGH SETTING
CLR	0 FLASHES
1 5 0 D 7 (PRESS D FOR DECIMAL POINT) AS AN EXAMPLE (IN THIS CASE 150.7 = 20 mA)	1 5 0 . 7 FLASHES
ENT (HIGH SET AT 150.7)	LAST COUNT READING

**STEP
8**

**SETTING
OUTPUT
PULSE
FREQUENCY**

D	MENU FLASHES TO DEV TYP ↓
D	LOCKOUT ↓
D	OUTCARD ↓
D	ALG OUT ↓
D	OUT FREQ ↓
ENT (OUT FREQUENCY SELECTED)	2000 ↓ (DISPLAYS LAST SELECTION)
D	200 ↓
D	10 ↓
D	20000 ↓ (PRESS D TO GO TO 2000)
ENT (PRESS AS DESIRED)	LAST COUNT READING

STEP
9

**SETTING
RELAY
FUNCTION
AND
ON TIMES**

PRESS	DISPLAY
D	MENU FLASHES TO DEV TYP ↓
D	LOCKOUT ↓
D	OUTCARD ↓
D	ALG OUT ↓
D	OUT FREQ ↓
D	RELAY ↓
ENT (RELAY SELECTED)	A GR TOTAL ↓ (RELAY A SET TO GRAND TOTAL)
D	A RATE ↓ (IF RATE SELECTED, DURATION IS DISABLED)
D	A TOTAL ↓ (RELAY A SET TO TOTAL)
ENT (PRESS AS DESIRED)	DUR A ##
CLR	DUR A 0.0
1 2 (AS AN EXAMPLE)	DUR A 1.2 (RELAY ACTIVATES FOR 1.2 SEC.)
ENT (ON TIME ENTERED)	B RATE ↓ (IF RATE SELECTED, DURATION IS DISABLED)
D	B TOTAL ↓ (RELAY B SET TO TOTAL)
D	B GR TOTAL ↓ (RELAY B SET TO GRAND TOTAL)
ENT (PRESS AS DESIRED)	DUR B ##
CLR	DUR B 0.0
5 5 (AS AN EXAMPLE)	DUR B 5.5 (RELAY ACTIVATES FOR 5.5 SEC.)
ENT (ON TIME ENTERED)	LAST COUNT READING

**VIEWING
RATE,
BATCH
TOTAL,
GRAND
TOTAL**

C	R ##### (RATE READING)
C	##### (BATCH TOTAL) PRESS C TO GO BACK TO RATE AGAIN
ENT	GR TOTAL FLASHES THEN THE GRAND TOTAL VALUE FLASHES
ENT	##### (BATCH TOTAL) PRESS C TO GO BACK TO RATE AGAIN PRESS ENT TO GO BACK TO GRAND TOTAL

**SETTING
16 POINT
K-FACTOR**

**16 POINT
ONLY
APPEARS
ON UNITS
WITH
16 POINT
OPTION**

NOTE: If TEST is entered, point data can be entered exactly as in selected time entries. However, when the unit "runs" in Test Mode "K-factor is always 1. "Rate" (R) displays frequency (inputs per second). Counter displays 1 count per each input.

NOTE: "BAD SEQ" will appear if frequencies are not in ascending order with point numbers. After 2 seconds, the first point number with error will appear so data can be viewed and corrected.

PRESS	DISPLAY
D	MENU FLASHES TO DEV TYP ↓
D	LOCKOUT ↓
D	OUTCARD ↓
D	ALG OUT ↓
D	OUT FREQ ↓
D	RELAY ↓
D	16 POINT ↓
ENT (16 POINT SELECTED)	MINUTES ↓
D	HOURS ↓
D	TEST ↓
D	SECONDS ↓ (PRESS D TO GO TO MINUTES)
ENT (PRESS AS DESIRED)	POINT 00 (ENTER POINT 00 TO GO TO RUN MODE)
1 (SELECT POINT 1)	POINT 01 (KEY IN POINT DESIRED)
ENT	F ## (SHOWS FREQUENCY IN MEMORY)
CLR	F 0
1 0 0 (AS AN EXAMPLE)	F 100 (FREQUENCY FOR POINT 1 IS 100)
ENT	K ## (SHOWS K-FACTOR IN MEMORY)
CLR	K 0
1 0 0 (AS AN EXAMPLE)	100 (K-FACTOR FOR POINT 1 IS 100)
ENT	POINT 02 (ENTER POINT DATA AS DESIRED)
CLR	POINT 00 (ENTER POINT 00 TO EXIT SETUP)
ENT	LAST COUNT READING

SPECIFICATIONS

Display

8 Digit, .55" Segment, Red Orange, LED.

Input Power

A: 110 VAC $\pm 15\%$ or 12 to 27 VDC

B: 220 VAC $\pm 15\%$ or 12 to 27 VDC

Current

Maximum 280 mA DC or 5.3 VA at rated AC voltage.

Output Power

(On AC powered units only): +12 VDC at 100mA. Separate isolated 12 VDC at 100mA to allow +12 VDC or +12 VDC regulated $\pm 5\%$ worst case.

Memory

EEPROM stores all program and count data for minimum of 10 years if power is lost.

Pulse Inputs

Standard, High impedance pulse input. Open or 0 to 1 VDC (low) 3 to 30 VDC (high) 10K Ohm impedance 20 KHz max. input speed (min. on/off 25 usec.).

Analog Inputs

The current loop or voltage input is converted to a highly linear 0 to 10KHz frequency. This frequency can then be scaled by the 8 digit K - Factors to count or display rate in separate engineering units.

Accuracy over full temperature range:

Zero error: $\pm 0.175\%$ full scale max.

Overall error: $\pm 0.5\%$ full scale max.

Reset

Front push button: "CLR" resets displayed number and control output.

Remote: 3 to 30 VDC positive edge resets batch counter and control output.

Impedance: 10K to ground (-DC)

Minimum pulse: 5 msec

Temperature

Operating: +32°F (0°C) to +130°F (+54°C)

Storage: -40°F (-40°C) to +200°F (+93°C)

Factored Output

The unit gives one pulse out for each factored count. Open collector sinks 30 VDC maximum to 1 volt maximum at 100mA maximum. Output speed is user selectable (see Table below). An internal buffer holds up to 10,000 pulses for output at the selected frequency before "DATA LOST" flashes, indicating pulses are lost. If factored rate exceeds 7 digits, "RFF..." flashes. These alarms indicated that speed has been exceeded.

Speed (Hz)	10	200	2000	20000
Min. on/off (msec)	47.5	2.0	0.2	0.013

Control Outputs

(Each of two outputs)

1) NPN Transistor Version: (Optional)

Open collector sinks max. 250mA from 30 VDC when active. (When relay is used, 10 VDC is provided at transistor outputs through relay coil. If greater than 2mA is used, relay will remain energized. Applying greater than 10 VDC may destroy unit. Transistor will sink 100mA in "ON" state).





















2.) SPDT Relay Version:

10A 120/240 VAC or 28 VDC (Standard)

Analog Output

Digital or analog inputs (except square law) can be ordered with a 4mA to 20mA output of the rate or total reading. User keys in the 4mA and 20mA settings at set-up. A sinking driver generates a corresponding linear current through the external devices, updating with each update of the rate or total. Accuracy is ± 100 uA worst case. Compliance voltage must be 3 to 24 VDC, non-inductive. (The unit can provide the DC source as long as the drop across any device being driven does not exceed 21 V).

TERMINATIONS

-  1- NOT USED
-  2- SCALED OUTPUT O.C.
-  3- ANALOG OUTPUT (SINK)
-  4- INPUT A (PULSE/ANALOG)
-  5- RESET INPUT
-  6- NOT USED
-  7- NOT USED
-  8- NOT USED
-  9- NOT USED
-  10- NOT USED
-  11- GROUND (-DC)
-  12- GROUND (-DC) INPUT COMMON
-  13- +12 VDC OUT
-  14- +DC POWER IN
-  15- ISOLATED -12VDC
-  16- ISOLATED +12VDC
-  17- AC IN
-  18- AC IN
-  19- PRESET B OPEN COLLECTOR
-  20- PRESET A OPEN COLLECTOR

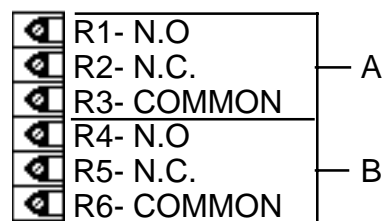

OPERATIONS

Presets

Two control presets are provided on the unit. The preset numbers can be made to flash without interrupting the control function by pressing "A" (Preset A) or "B" (Preset B). Press "ENT" to return to rate or total display. Change the preset by clearing the flashing preset number and keying in a new number before pressing the "ENT" button. (Count pulses may be lost if the preset is changed while pulses are coming in.) In the "Relay Set-Up" the user selects either one or both preset outputs to be activated the total, grand total, or rate. If selected for total or grand total the outputs can be set to activate the preset relay for 0.1 to 9.9 seconds or latch (0.0 setting) until reset. If selected for rate control, the rate will be compared with the preset at each display update and the output activated if the rate is equal or greater than the preset. The output drops out again only if the rate drops below the preset. If the rate goes out of scale, the display will show all "F" and the output will remain in the state prior to going out of scale.

Outcard

RS232 or RS422 serial two way communication options are available. Up to 15 units can be linked together and addressed separately to transmit unit status or accept new set points in the standard ASCII format. Baud rates of 300, 600, 1200, 2400, 4800 or 9600 as well as choice of odd, even, space or mark parity can be selected by keypad control.

- OPTION 1: RS232 Serial Interface
- OPTION 2: RS422 Serial Interface
- OPTION 5: RS422M Serial Interface

Lockout

Unauthorized front panel changes can be prevented by entering a user selected 4-digit code, in the "LOCKOUT" mode. A (2) level "LOCKOUT" offers the user the option to "LOCKOUT" all front panel changes or "LOCKOUT" all but preset A, B, and CLR. The status of the unit can be observed but, "LOCK ON" appears if changes are attempted. Entering the code returns the unit to "LOCK OFF" status.

RATEMETER

Accurate to 5 1/2 digits (± 1 display digit). The rate meter can be programmed to accept almost any number of pulses per unit of measurement, sample from 2 to 24 seconds maximum, and autorange up to 6 digits of significant information. The rate meter with a "K" factor of 1 displays the rate of pulses per second. Simply dial in the proper "K" factor to display in minutes, hours or other units of measurement.

Press the "C" button while the units is displaying the batch to display the rate; "R" is displayed on the left side of the display.

K-FACTOR

The K-Factor is used to convert the input pulses or frequency generated internally by the analog input to engineering units. The 8 digit K-Factor dividers, with decimal keyed into any position, allow easy direct entry of any K-Factor greater than 0.0001 to 99999999.

Separate K-Factors may be entered for the count and rate section. Thus, you may batch and total in gallons and display rate in liters per hour. The maximum factored count speed is 20,000 Hz. The maximum factored rate is 7 digits.

A 16-Point Linearization variable K-factor option makes flow systems more accurate and often extends their usable range by allowing users to dial in different K-factors for different flow rates. It works with either pulse input or standard analog current loop or voltage input.

It is recommended for flow meters whose K-factors change with different rates of flow. This option can also be used to display static volume in irregular shaped vessels by interfacing level or pressure transducers to the analog input.

From 3 to 16 points of frequency from 0 to 10,000 Hz and K-factors greater than .0001 to 999,999 are dialed in at set up. The unit uses 8-digit floating math to interpolate between settings. Rate per second, per minute or per hour programmability eliminates the need to calculate separate K-factors for total and rate.

COUNTER

Each of the total and grand total counters have 8 digits. In the set-up mode choose "RO" (reset to zero) for adding operation or "SP" (set to preset) for subtracting operation. While viewing the count, the display can be made to flash the grand total. While flashing the grand total, CLR resets the grand total counter.

APPLICATION

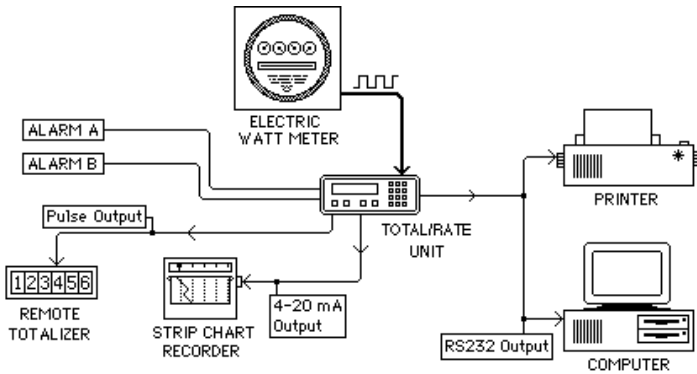

The unit monitors the power consumption and transmits the rate, total or grand total usage upon command to a printer, PLC or computer. Either control Relay A or Relay B can be activated by rate, total or grand total readings. If Relay A is set for rate, it can activate an alarm for load management if the preset usage is exceeded. Relay B can be set to activate at any rate, total or grand total alarm setting. The customer has it his way when selecting the external devices to record the unit data. A frequency selectable pulse output can drive any totalizer, PLC, computer or other pulse input device from 10 to 20,000 Hz. With the analog output option the customer keys in both the 4mA and 20mA rate settings and the unit drives the strip chart recorder, load shedding or other monitor devices. Finally, with the RS232/RS422 or RS422M option the customer can have a printer record any data or have a computer communicate with up to 256 units to monitor the usage, change alarm points, reset the internal counters, etc. from a remote location.

MOUNTING DIMENSION

Dimensions are in inches (mm)

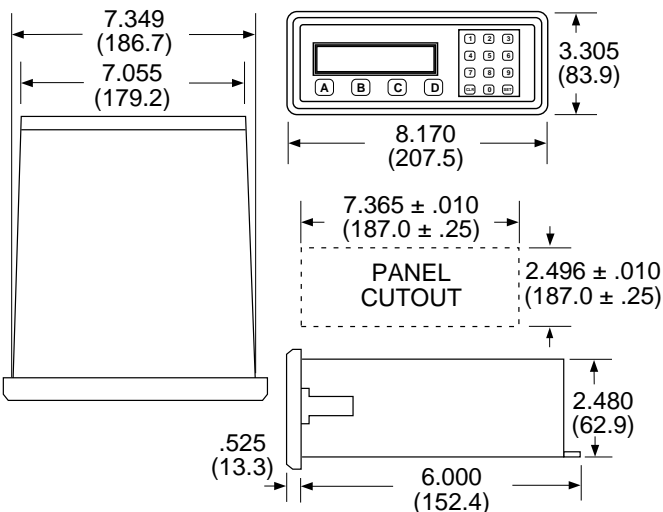

PULSE INPUTS

The unit accepts output pulses from most encoders, prox. switches or contactors. Connect the pulse to Input A Pin 4.

The unit counts on the negative edge of a pulse: Low: 0 to 1 VDC, High: 3 to 30 VDC.

SOURCING INPUT - Has a 10K Ohm pull down resistor to ground and must be driven high by a sourcing device such as a PNP transistor or a contact to +DC, Pin 13.

SINKING INPUT- Has a 4.7K Ohm resistor to +12 VDC and must be driven low by a sinking device such as a NPN transistor or a contact to ground (Pin 12).

PULSE SPEED

The Max input speed is specified by the 8th digit of the part number based on a 50% on/off pulse. Although the unit can accept pulses as short as 25 usec on/off if speed "E" is selected, it is advised that only the maximum speed needed be ordered. When lower speeds are specified, additional filtering is added that make the inputs more immune to electrical noise. "A" input speed should always be used when pulsing with a switch contact to prevent additional erratic count inputs.

INPUT SWITCH SELECTION

Inputs use an input signal conditioning board which is plugged onto the main board just behind the display. It has dip switches which set the debounce filtering (max. count speed). (See section for "Removing Case" to get to the input modules if changes on the pulse input board are needed.)

S1, S2 determine debounce filtering and control max. input speed,

(A) S1, S2-ON, 0-40 Hz (min. 12.5 msec on/off)

(C) S1-ON, S2-OFF, 0-400 Hz (min. 1.25 msec on/off)

(E) S1, S2-OFF, 0-20K Hz (min. 25 usec on/off)

S3, S4 set the input characteristics as designated by the 5th and 6th digits of the part number.

SOURCING INPUT: S3, S4-OFF (needs sourcing input)

SINKING INPUT: S3-OFF, S4-ON (needs sinking input)

ANALOG INPUTS

The analog input versions accept signals from transmitters that give linear outputs. The input signal modules are mounted just behind the display and are calibrated for the input specified. Insure that the sensor output matches the unit input. Connect the analog signal to input A (Pin 4) with the return to ground (Pin 12).

SQUARE LAW: 4-20mA; 250Ω input impedance, the square law input is a special input that compensates for non-linear inputs. Specifically, inputs that require square root extraction to provide accurate count and rate determinations. The input signal is converted to 0 to 10,000 pulses per second input to the process (see Table below).

4-20mA Square Law Table

<u>mA Input</u>	<u>Pulse/Sec</u>	<u>mA Input</u>	<u>Pulse/Sec</u>
4	0000	10	6123
5	2500	12	7071
6	3535	16	8660
7	4330	18	9354
8	5000	20	10000

To calculate the Pulse/Sec for a particular input use the following formula:

$$\sqrt{\frac{\text{mA} - 4 \times 10000}{16}} = \# \text{ Pulse/Sec to Processor}$$

EXAMPLE: To calculate the Pulses/Sec for 9mA Input.

$$\sqrt{\frac{9 - 4 \times 10000}{16}} = 5590 \text{ Pulses/Sec to Processor}$$

CALCULATING THE K- FACTORS

The analog inputs are converted to a highly linear 0 to 10000 pulse per second frequency. The high level of any analog input will generate this 10000 Hz frequency. The pulses go directly to the central processor. The K- Factors are used to convert the pulses into the correct units of measurement.

Rate K- Factor: 10000/R, where R = high output rating (20mA or 5V) of transmitter. 10000 divided by 20mA or 5V rating of transmitter. Eg. 20mA rating of transmitter is 250 gal. per min. The rate K - Factor to key into the unit for gal. per min. is 40 (10000 divided by 250).

If a rate is desired in a different unit of measure or a different timebase, factor the transmitter rating to the unit of measure and timebase desired and use the formula above. Eg. 5V output rating of a transmitter is 300 gal. per min. and rate desired is liters per hr. The factored rate for this transmitter for liters per hr. is 68135.94 (300 x 3.78533 [gal. to liters] x 60 [min. to hr.]). The rate K - Factor for liters per hr. is 0.1467654 (10000 divided by 68135.94).

Counter K-Factor: = 10,000/R/Sec, where R = High output rating (20mA or 5V) of transmitter factored to rate per second. Eg. 20mA rating of transmitter is 500 gal. per min. Rate per sec. is 8.3333333 (500 divided by 60). Counter K-Factor to key into unit is 1200 (10000 divided by 8.3333333).

If a different unit of measure is desired, factor the given transmitter rating to the desired unit of measure in units per second and use the formula above. Eg. 5V rating of transmitter is 250 gal. per hr. and it is desired to totalize in liters. Rate in liters per second is .2628701 (250 x 3.78533 [gal. to liters] divided by 3600 [hr. to sec]). Counter K-Factor to key into unit to totalize in liters from 250 gal. per hr. transmitter is: 38041.603 (10000 divided by .2628701).

ANALOG INPUT EXCHANGE/CALIBRATION

If an analog sensor cannot be obtained that matches the unit input, it is recommended that the unit be returned to have the analog input module exchanged and recalibrated.

Recalibration should only be attempted by someone who has the equipment to generate a very accurate low and high signal and who has the training to open the unit and work with grounded equipment necessary to protect the static sensitive CMOS circuitry.

Set the ratemeter as follows: K Factor = 1, sig. fig. = 6, window = 02 and the weight = 0. See the section "Removing the Case" to get at the analog input card, mounted just behind the display. There are two pots that set the "0" (R3) and 10000 Hz (R15) frequency. R3 and R15 are silkscreened just under the .3 inch square pots. While inputting a very accurate high input signal. Set R15 so that the display reads 9999 to 10000. Remove the input signal and adjust R3 so that the display reads "0". Readjust R15 until it is as close as possible to 10000. Go back and readjust R3 to insure it is at "0". Repeat this procedure until both the "0" and "span" pots are set properly.

RESET

REMOTE

The reset is positive edge active; once reset, the unit will accept new data even if reset is held. Applying a 3 to 30VDC pulse of minimum 5 msec resets the batch counter and control output. Impedance 10K to ground (-DC).

FRONT PUSH BUTTON RESET

Pressing the front CLR button will reset the control output and any displayed number (load the "Preset A" number into the display if "SP", subtracting mode of operation, has been selected).

AUTO RESET

To recycle the unit, choose the preset which is to activate the reset and set it's "Relay Duration" as short as possible. Place a 10K Ohm resistor between reset (Pin 5) and the chosen transistor output for the preset chosen (Pin 19 or Pin 20). The relay acts as a pull up resistor and the unit resets after the control output "times out". After the unit is reset it will operate even though the reset is high. The reset is edge triggered and only resets when the input goes high. Note that if Pin 5 is pulled high by a resistor, it must be pulled low a min. of 5 msec and then allowed to go high to reset the unit.

FACTOR/"DATA LOST"/"RFFF..."

The K- Factor is used to convert the frequency generated internally by the analog input to engineering units. The 8 digit K -Factor dividers, with decimals keyed into any position by use of the "D" button, allows easy direct entry of the desired K - Factor. A separate K - Factor may be entered for the count and rate section. Thus you may batch and total in gallons and display rate in liters per hour. NOTE: If the counter K - Factor is .0001 or less or if the factored count speed exceeds 20000 CPS, "DATA LOST" flashes. If the input divided by the rate K - Factor exceeds 7 digits "RFFF..." flashes. These alarms indicate that the factored speed has been exceeded and data is invalid. Increase the K - Factor divider.

COUNTER

The unit accumulates up to 8 digits of batch and grand total count. In the setup mode choose "R0" (Reset to Zero) for adding operation or "SP" (Set to Preset) for subtracting operation. While running display can be made to display an 8 digit grand total by pressing "ENT" while the unit is running. Activating "CLR" while the grand total is flashing, resets the grand total counter.

PRESETS

The unit has two independent presets. In the setup mode the user selects whether the Counter, Rate Meter or Grand Total counter activates either or both Preset A and Preset B outputs. The preset numbers can be displayed or updated at any time by pressing "A" (Preset A) or "B" (Preset B). Enter the flashing preset number or press "CLR" and key in a new number and "ENT" to enter it.

If the Total or Grand Total counter is set to control an output, that output will activate for the time duration selected under "RELAY" when the counter reaches the selected preset number.

If the Rate is set to control and output, that output will be activated when the rate equals or exceeds the preset rate and drop out again when the rate goes below the preset rate. Note that the preset for rate can be entered with decimal when keying in the rate preset number.

RELAY - OUTPUT TIMING

Control output timing is selected by pressing D until the RELAY mode is selected and entered. Any time duration from .1 to 9.9 seconds or latch until reset (0.0 setting) may be entered for the A and B outputs. Once the output has been activated, the unit must be reset before another output will occur.

SCALED OUTPUT/DATA LOST

The unit generates a pulse out for each factored count. An NPN transistor output (Pin 2), capable of driving 100mA from 30 VDC max., can drive external devices at rates of 10, 200, 2,000 or 20,000 counts per second as selected through keypad menu. (Min. on/off times in milliseconds are 47.5, 2.0, 0.2 and 0.013 respectively). If the inputs scaled by the K - Factor generate faster pulses than the output speed selected, an internal buffer will store up to 9,999 counts before "DATA LOST" flashes on the screen. This indicates that the counts being totaled and the scaled outputs may be incorrect. Note that all counts being totaled and the scaled outputs may be incorrect. Note that all counts stored in the internal buffer will be pulsed out at the selected frequency even if the counter is reset.

RATE METER

Accurate to 5 1/2 digits (+ one display digit); the ratemeter is autoranging and can be programmed by the K - Factor to display almost any engineering unit of measurement. To display the rate press the "C" (RATE/TOTAL) button while

the unit is displaying the batch. "R" is displayed on the left side of the display to indicate that rate is being displayed. The unit calculates the rate from the period between pulses. The unit measures the average time between pulses, divides this by the K - Factor and a reciprocal math calculation to find the rate per second. As long as pulses come in faster than 3 per second the unit will update each second. The 2 to 24 second "WINDOW" time, selected at set up, is the maximum time the unit will wait for sufficient pulses to make an accurate calculation before it displays zero.

1 to 6 "SIG FIG" (significant figures) can be selected in the set up mode. The unit will normally display the number of digits selected. The unit is auto ranging and will place the decimal within these digits to display the true factored rate. If the rate, scaled by the K - Factor, has more digits to the left of the decimal point than the number of significant digits selected, additional zeros will be added to fill in digit spaces to the left of the decimal place. Eg. Factored rate is 123.456. A: "SIG FIG" set 4, display reads 123.4 B. "SIG FIG" set 2, display reads 120. This allows the user to show either the exact rate with the least significant digits changing with only a slight rate change or to create a more stable display by showing zeros in the less significant digits.

NOTE: If the rate exceeds 7 digits, the display shows "RFF..." indicating speed has been exceeded.

SETTING RATE K - FACTOR FOR PULSE INPUT

K - Factor (rate per sec.) = pulses per unit (gallon, foot, revolution)

K - Factor (rate per min.) = $\frac{\text{pulses per unit}}{60}$

K - Factor (rate per hr.) = $\frac{\text{pulses per unit}}{3600}$

The rate meter with a K - Factor of 1 displays the rate of incoming pulses per second. To display the frequency or rate per second simply key in the number of pulses per gallon, revolution, foot or other unit of measurement. This will usually be the same as the K - Factor used for the count. If it is desirable to display the rate per minute, or hour, divide the pulses per unit of measurement stated on the sensor by 60 (rate per minute) or 3600 (rate per hour). Example: A sensor generates 850 pulses per gallon and you want to display gallons per hour. Set the counter K - Factor at 850 to batch in gallons. Set the rate K - Factor at 0.2361111 (850 divided by 3,600). To convert to other units of measurement calculate the number of pulses for the desired unit of measure and use the formula above. Example: Sensor give 850 pulses per gallon and you want to batch in liters and display in liters per minute. (Example uses conversion 1 gallon equals 3.78533 liters). Counter K - Factor = 224.55109 (Sensor gives 224.55109 pulses per liter - 850 divided by 3.78533). To find the rate per minute K - Factor divide the count K - Factor for liter (224.55109) by 60 (seconds per minute) = 3.7425181.

LOCKOUT

Unauthorized front panel changes can be prevented by entering a four digit code chosen by the user in the LOCK-OUT setup mode. The unit leaves the factory with code 1,000. (If a code of less than 4 digits has been entered, the unit adds prefix "0's" to make a four digit code.) The selected code should be recorded in a safe place. A choice of two level lockout offers the user the option to lockout all front panel changes or lock out all but presets A, B and CLR. Entering the code in the set up mode does not disable the keypad, but keying in the four digit code while in the run mode will activate "LOCK ON". The status of the presets, rate and grand total can be viewed but "LOCK ON" appears if changes are attempted. Only by keying in the four digit code into the keypad while the unit is in the run mode will the unit return to the "LOCK OFF" status.

REMOVING THE CASE

To install or change the input or data interface cards, the case must be removed. Before opening case, remove all power. CMOS logic is used. Use standard precautions against damage by static discharge. If the unit has a data interface option (RS232/422/422M), two screws in the back, designed to secure the top left connector, may have to be removed. Next remove the six (6) flat head 4-40 x 1/4" screws behind the panel and lift off the panel/lens assembly. Slide the main board display out the front of the case. Once modifications are made, reverse the procedure to re-assemble the unit, insuring that the main board is in the track. The six (6) screws that hold the panel must be tight to seal the rubber keypad panel assembly, approximately 0.6 in" lb. torque.

INPUT CARD MODIFICATION

Follow "Removing the Case" procedure. The Input Card is mounted just behind the display and plugs onto the 15 pin post connector. Remove the board and make desired changes. When installing the input card, insure that the component side of the board is facing the front and that the 15 pin connector is mated to the proper pins and not offset to the side. Replace the front panel.

INTERFACE INSTALLATION - RS232/RS422/RS422M

Follow "Removing the Case" procedure. The RS232 and RS422 cards have a 15 contact ribbon cable that plugs into the female connector next to the heat sink. Choose the proper interface card. With components on top and subminiature connector to the back, plug in the harness and mount the card on the four (4) standoffs provided. After the main board is inserted into the case, replace the front panel.

OUTCARD RS232/RS422SERIAL INTERFACE

If the serial interface option is supplied, up to 15 units can be linked together. (See "Strobe Input Operation" to link more than 15 units). Units status and new set points can be communicated by remote hook-up. Mode changes, however, must always be made on the front keypad. Data is transmitted at selected baud rates using standard seven bit

ASCII characters and parity with two additional bits of "Start" and "Stop" to make up the standard ten bit character. (See Unit setup to select and enter desired Code Number, Baud Rate and Parity). RS422M has automatic baud rate selection and uses an eight bit word, up to 256 units can be linked together.

UNIT CODE

Each Unit in the hook-up must be assigned a code number from 1 to 15 through the front keypad in the "Outcard" set up mode. Number "00" is reserved for a dedicated hook-up to only one terminal and its transmit output line remains in an "on" active state. (Units assigned other numbers have outputs that remain in the "off" high impedance state until addressed by their code number or brought on line by positive edge of Strobe input). Once a unit is addressed, do not address another unit until the data has been entered, a "Carriage Return" has been sent and any data requested has been transmitted back.

BAUD RATE

The baud rate is the speed at which data is transmitted, expressed in bits per second. Baud rates of 300, 600, 1200, 2400, 4800 or 9600 are available. Use the front keyboard to call up the "Outcard" set up mode and select the desired baud rate that is compatible with the remote terminal.

PARITY

Parity is a bit of information that is inserted before the stop bit is used. It is used to help check that the transmission is correct. In the "Outcard" set up mode, select between "Odd" (Parity bit is logical zero if total number of logical 1's in the first seven data bits is odd) "Even" (Parity bit is logical zero if total number of logical 1's in the seven data bits is even), "Mark" (Parity data bit always logical 1 - high/Mark), "Space" (Parity data bit always logical 0' low/Space). If a "Mark" parity is chosen, it will appear that two (2) stop bits are used. Use the "Mark" parity with terminals using parity "OFF" or "NONE". These terminal ignore the parity. The unit does not check the parity but does transmit the parity chosen. If the parity requirements of the interface terminal are not known, it is often practical to key in a different parity until the correct one works.

RS232 ELECTRICAL REQUIREMENTS

Standard E1A specifications. Standard inputs must present a load of 3000 to 7000 Ohms. A voltage level of +3V to +25V (referenced to signal ground) is read as a "Space" or "0" and indicates an active state (asserts a control line). A voltage level of -3 to -25V is read as a "Mark" or "1" and does not indicate an active state (does not assert a control line). Outputs must send a voltage of +5 to +25V (referenced to signal ground) for a "Space" and a voltage of -5 to -25V for a "Mark" when loaded with a 3000 Ohm load to signal ground. Outputs must be capable of being shorted to other signal lines without burning out. It is normally recommended that cable length be limited to 50 feet.

RS422 ELECTRICAL REQUIREMENTS

The input of the unit follows the standard E1A high impedance minimum of 12K Ohms. When the 422 + (A) input is more positive than the 422 - (B) input by .2V to 6V, a "1" or "Mark" condition is recognized. When the 422+ input .2V to 6V, a "0" or "Space" is recognized. Data is recognized by the polarity of the voltage difference between the two lines. Noise picked up on the line will make little difference since the noise is usually added to each line, and the voltage differential remains the same. The output driver drives the transmit lines to a differential of 2 to 6V. It is designed to handle loads up to 60mA of sink or source current and features positive and negative current limiting for protection from line fault conditions. Since the RS422 is more immune to noise, cable links up to 1000 feet or more can be used. Because of the high input impedance of RS422, line terminating loads are recommended. For hook up to a single unit a 150 to 200 Ohm resistor across Receive Data + or - at the unit and at the remote terminal is often sufficient. For multiple hook-up, other standard terminations should be used. Total loading should not be greater than 90 Ohms.

RS232/RS422 SERIAL INPUT CODES

DXX(S) (Device and address number followed by space) activates the unit that has been assigned that number. That unit comes on line and transmits "Device XX:". Unit is now ready to receive a code or string of codes separated by a space. A "Carriage Return" (Enter) code enters the codes and processing of requests begins.

CODES

DC	Will transmit count.
DR	Will transmit rate.
DT	Will transmit grand total.
KC	Will transmit counter K-Factor.
KC(S)XXX	Will load counter K-Factor number.
KR	Will transmit rate K-Factor.
KR(S)XXX	Will load rate K-Factor number.
PA	Will transmit Preset A.
PA(S)XXX	Will load preset A number.
PB	Will transmit Preset B.
PB(S)XXX	Will load Preset B number.
RC	Will reset counter to zero if in "RO" mode (adding) or set counter to Preset A if in "SP" mode (subtracting). Output is reset.
RC(S)XXX	Will set counter to number (no other change is made).
RT	Will reset grand total to zero.
RT(S)XXX	Will reset grand total to number.

SERIAL INTERFACE OPERATION

Data is received and transmitted over standard EIA RS232 or RS422 levels. Each 10 bit character is made up of a start bit, 7 bit ASCII code, parity bit and stop bit. Unit number, baud rate and parity are entered in the "Outcard" set up mode and remain in memory even if power is off.

Note that the input impedance of RS232 is 3K or 7K Ohm worst case. The terminal addressing the unit must be capable of driving all loads in the loop. RS422 input impedance is much higher and there is usually no problem driving 15 units. Unit serial transmit line remains in a high impedance "OFF" state until addressed. Insure that only one unit is addressed at a time.

To address unit, transmit a "D" (device) followed by the 1 to 15 code number and a "Space". Once the "Space" has been received, the unit becomes active and responds back, "Device XX:" (Device number). (Once active, the unit works in a full duplex, echo back mode, so that data sent from the terminal will be transmitted back for verification). Once the unit is "on line", use the proper serial transmit codes to request data or set a new value. (See RS232/RS422 Serial Input Codes). Up to 80 characters of data may be linked together and transmitted to the unit in a string as long as there is a space between the different codes. If an error is made, a correction can be made by back spacing and retyping correct data before the "Carriage Return" (Enter) is sent, the unit starts processing the data and will transmit the requested data on a non-priority basis over the data transmit line. A unit keypad entry or incoming data will halt the data communication cycle. Therefore, there should be a pause after data is requested to insure that all data has been transmitted before another unit is addressed and brought on line. (If the unit is not busy, It should not require more than 5 msec to process each request. To find the cycle time to process and transmit a request, calculate the bit transmit time by dividing 1 by the baud rate; multiply by the number of requests made. Example: Typical time to transmit 1 uninterrupted request at 300 baud rate is .272 sec. $(1-300) \times (80) + .005$.)

This time will be extended if the unit must service the front keypad or one of the inputs. In practice if transmission has not started within 2 seconds after data is requested, It can be assumed that there is a problem).

When transmitting, the unit will precede each data value with a "Carriage Return" and "Line Feed" code and answer only with requested data in the order the requests were made. After all requested data has been transmitted any new communication must be started again by DXX (Device number) and space.

Following are two examples of requests and responses.

<u>Transmit from</u> <u>Terminal</u>	<u>Receive from</u> <u>Unit</u>
(S) = Space	
Example A:	
D13(S)	Device #13
[Unit #13 Activated]	
PA(S)76546(S)PA(S)	PA 76546 PA
KC(S)1575(S)KC(S)	KC 1575 KC
RC(ENTER)	RC
[Unit presets and counter K-Factor are set, counter is reset]	
	76546
	1575

Example B:	
D7(S)	Device #7
[Unit #7 Activated]	
PA(S)12347(S)PA(S)	PA12347 PA
RC(S)456789(S)DC(S)	RC 456789 DC
RT(S)376(S)DT(ENTER)	RT 376 DT
[Unit preset, counter and total count are set]	
	12347
	456789
	376

STROBE ADDRESS OPERATION

Another method of reading the status of a unit with either a RS232 or RS422 option is by means of a separate strobe address and a 3 bit data request code. Use of the strobe address method does not allow the input of new set points but theoretically hundreds of units could be linked together to transmit the data in the unit over the serial transmit line in the standard RS232 or RS422 format. The unit could be assigned any code number other than "00".

The 3 bit data request code would be latched in at the positive edge of a 3 to 30 VDC strobe input that remain high a minimum of 25 milliseconds. Requests are processed on a nonpriority basis. Normally data will begin to be transmitted from the unit over the RS232 or RS422 serial transmit line within 5 msc unless interrupted by a keypad entry or other signal input.

No other unit should be brought on line until data requested has been transmitted.

STROBE INPUT ELECTRICAL REQUIREMENTS

Both the RS232 and RS422 interface option cards have inputs that allow data to be requested over a separated strobe input and a 3-bit data request code input. Any number of the 3 data request code lines can be linked in parallel as long as the source can drive the combined load of all inputs linked together (1.5K Ohm divided by the total number linked together). Data is transmitted over the serial lines using standard RS232 or RS422 characteristics. Strobe and data ground as reference:

STROBE INPUT LEVELS

0 or low:	Open or 0 to 1VDC
1 or high:	3 to 30 VDC
Impedance:	1.5K Ohm

STROBE INPUT CODES (Octal Code)

0:	PA (Preset A request)
1:	PB (Preset B request)
2:	KC (K-Factor or counter request)
3:	KR (K-Factor of rate request)
4:	DC (Display of count request)
5:	DT (Display of grand total request)
6:	DR (Display of rate request)

HOOKUP

RS232/STROBE
(SUB-D 25 PIN CONN.)

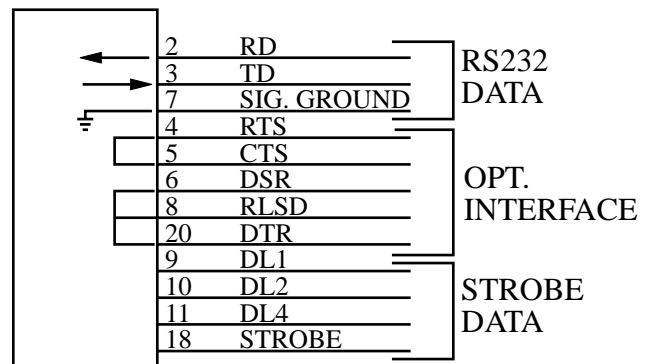

RS232 WIRING

The unit requires only three wires for RS232 communication: Pin 7 (Signal Ground), Pin 2 (Receive Data), Pin 3 (Transmit Data). Pin 4 (Request to Send) are jumped internally to echo back the signals. Pins 6 (Data Set Ready), 8 (Received Line Signal Detector) and 20 (Data Terminal Ready) are also jumped internally to echo back any signal.

The unit RS232 option has a subminiature D25 pin female connector and is wired as a DCE (Data Communications Equipment) device. If it is connected to a DTE (Data Terminal Equipment) device, the interconnect cable should have wires 2 and 3 connected straight to the same pins on each end. If it is connected to another DCE device, Pins 2 and 3 must be crossed so that the wire to Pin 2 on one end goes to Pin 3 on the other end and Pin 3 on one end goes to Pin 2 on the other end.

STROBE WIRING FOR RS232

The 3 data lines to generate the request code (DL 1: Pin 9, DL 2: Pin 10, 2: DL 4 Pin 11) must be set and remain constant while the positive strobe of at least 25 milliseconds is given on the strobe input (Pin 18). Data is transmitted in RS232 serial format on Transmit Data Line (Pin 3).

RS422 WIRING

The unit RS422 option has a subminiature D 37 pin female connector and is wired as a DCE (Data Communication Equipment) device. It is designed to be connected to a DTE (Data Terminal Equipment) device. If it must be connected to a DCE device, it will be necessary to cross wires 4 and 6 as well as 22 and 24 at one end of the connector harness. The unit requires only 5 wires for RS422 communications; Pin 22 [Receive Data + (A)], Pin 4 [Receive Data - (B)], Pin 24 [Transmit Data + (A)], Pin 6 [Transmit Data - (B)], Pin 20 (Sig. Ground). The following groups of pins have been jumped internally to echo back the signals: (7, 9), (25, 27), (11, 12, 13), (29, 30, 31). Signal ground (Pins 19, 20) must be connected to provide a common reference

HOOKUP

RS422/Strobe (SUB-D 37 Pin Conn.)

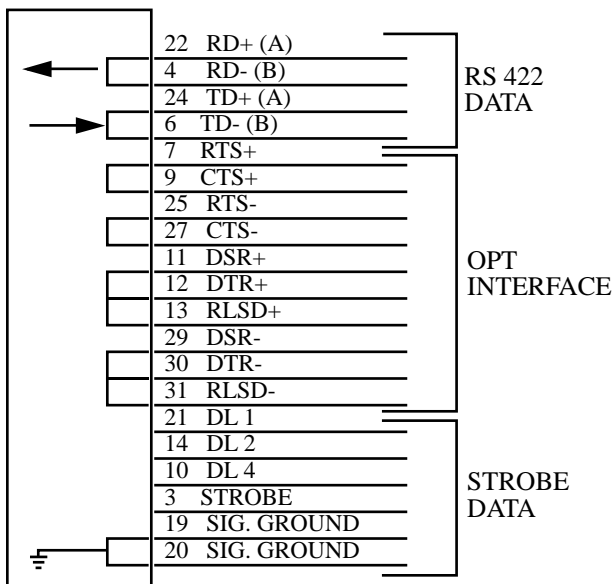

STROBE WIRING FOR RS422

The 3 data lines to generate the request code (DL1: Pin 21, DL2: Pin 14, DL4: Pin 10) must be set and remain constant while the positive strobe of at least 12 milliseconds is given on strobe input (Pin 3). Data is transmitted in RS422 serial format on Transmit Data Lines (Pin 6-24).

ANALOG OUTPUT

When used with a digital input, the Analog Output module is separate and plugs on just to the right of the input module. When used with analog input (7A to 7E), the Analog Output logic is combined on one analog input/output module. (The white wire from the module plugs onto pin J2-6). The output on external pin 3 is a 4mA to 20 mA output corresponding to the selected rate readings. A sinking driver generates a linear current across recorder, PLC, computer, external meter. In the program set up mode the user is prompted to "SET LOW" (4mA rate) and "SET HIGH" (20mA rate).

The unit can supply the 24VDC to power the current loop. (Connect Pin 15 to Pin 13. Pin 16 is now + 24VDC with respect to Pin 12). With Pin 15 connected to Pin 13, connect Pin 16 to the + DC side of the external device and connect Pin 3 to - DC side of the external device.

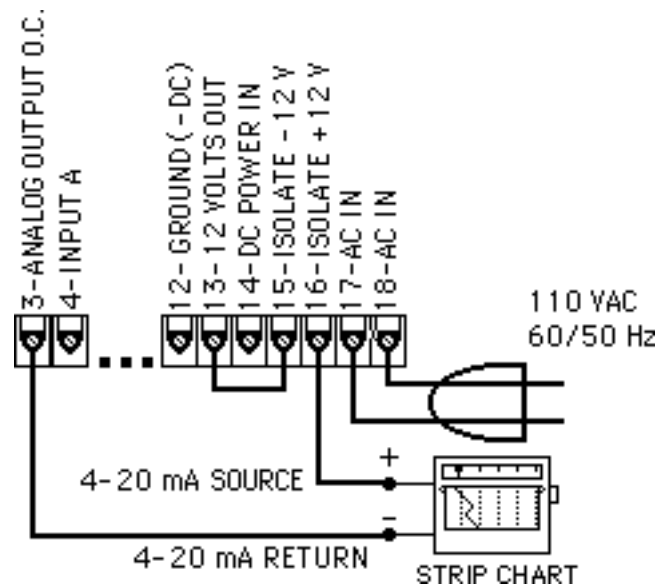

OPTIONAL 16-POINT LINEARIZATION OF VARIABLE K-FACTOR

DESCRIPTION

The 16 point K-Factor option allows the user to dial in from 3 to 16 different frequency points (inputs per second) and different K-Factor dividers from 0.0001 to 99999999 for each of these frequencies.

The 16 point unit determines the incoming frequency and calculates a K-Factor line slope from the two closest data points that had been entered. The "specific K-Factor" is then proportionally interpolated using 8-position floating math. This K-Factor is applied to all inputs until the next frequency calculation, usually 1 second later. If a "0" frequency is entered into "point 1", the "point 1" K-Factor will be applied to all inputs received before the first frequency calculation.

The rate can be displayed in 3 ways: "SECONDS _", "MINUTES _", "HOURS _", or "TEST _". If "SECONDS _" is selected, the unit displays the "base rate" calculated from the incoming frequency and the "specific K-Factor". If "MINUTES _" is selected, the rate displayed is 60 times the "base" rate. If "HOURS _" is selected, the rate displayed is 3600 times the base rate.

POINT DATA FORMATTING

Each Frequency/K-Factor data entry is assigned a point number. Any point number may be selected to view and/or change the Frequency/K-Factor data as long as the frequencies of the ascending frequencies. "BAD FREQ" will flash when exiting the set up mode if there is a sequence error. The unit will then display the sequence error point # so that corrections can be made.

NOTE A: Unit defaults "0" K-Factor to K-Factor of "1" since it is impossible to divide by "0".

NOTE B: "Point 01" will be the "low shut-off" frequency. Below this frequency no rate will be displayed nor count recorded. Point 01 should be assigned a frequency of "0" with a K-Factor for lowest flow especially if very slow flow is to be counted.

NOTE C: The entry of a frequency of "0" for "Point 03" or above will tell the unit to continue the K-Factor slope line calculated from the two previous Frequency/K-Factor points and ignore any higher point data. If a fixed K-Factor is desired, assign the same K-Factor to two ascending frequency points and enter a frequency of "0" in the next higher point entry.

NOTE D: K-Factors are always positive numbers. To avoid undesired K-Factors projected around "0" K-Factors, insure that a positive K-Factor is assigned for the highest used frequency.

NOTE E: The decimal in the "Total" and "Grand Total" is a dummy. The K-Factor should be calculated to show all numbers as if there were no decimal and then decimal added under DEC LOC section of DEV TYP MENU.

Note that the autoranging decimal in the rate (R) display will be shifted to the left as the "Dummy Decimal" is shifted to the left so that the rate display will be the same as the count. Example: A meter gives 33.4 pulses per gal. and it is desired to display in 1/10 gal. Move K-Factor decimal place to the left and key-in a decimal under DEC LOC MENU. K-Factor for gal. and 1/10 is 3.34 Rate will show 3.34 with decimal added while it would show 33.4 if no decimal were added.

TEST MODE

A special "TEST" mode can be selected to help set-up the points and K-Factors. If "TEST" is selected, the RATE ("R" display) will show the frequency (pulses per second) of the incoming signal. The TOTAL section will accumulate one count for each incoming pulse.

TEST MODE K-FACTOR CALCULATION

Calculate the K-Factors for flow meters with pulse or analog transmitters:

- A) Set the 16 point units to "TEST" and ENT point 00 to go to the run mode.
- B) At the lowest desired flow rate, rest the counter and let the unit count the incoming signal while the rate displayed is recorded.
- C) Interrupt the input signal when the known tested volume has gone through the flow meter. Switch to count display and read the number of counts that came in from the known volume as displayed on the unit. Divide the counts by the volume that past through the meter to determine the number of counts for 1 unit of measure, gallon, cubic foot, etc.
- D) Record this frequency and K-Factor for later entry into point 1 or point 2. (See NOTE B above to determine if data should be entered in point 1 or 2).
- E) Assign ascending point numbers to correspondingly ascending frequencies when recording frequency/K-Factor data. A minimum of 3 points and a maximum of 16 points must be entered.

DATA ENTRY FOR 16-POINT

Press "D" until "16 POINT" appears on display. ENT.

Press D to step through options:

SECONDS (Scaled rate per second selected)

MINUTES (Scaled rate per minute selected)

HOURS (Scaled rate per hour selected)

TEST (Test mode-rate per second with 1

count for each input (fixed K-Factor of 1) selected)

Press ENT when selected option is displayed.

Point 00 will appear on the display. ENT "POINT 00" to exit the set up and go to run mode or key in a point number from 1 to 16 and ENT.

"K" will flash with present K-Factor for that point. ENT or CLR and key on desired K-Factor.

Continue to step through the POINT numbers to view or change data. If a frequency of 0 is entered, in POINT 3 or above, the unit will ignore data above that point number. A K-Factor generated from the line slope of the 2 previous POINT entries will be applied to higher frequencies.

Exit "point set" routine by setting to POINT 00 and ENT.

Unit will go to run mode. "BAD FREQ" will flash when exiting the set up mode if there is a sequence error. The unit will then display the sequence error point # so that corrections can be made.

If "TEST" is selected, point data can be entered into memory but when running, unit will add one count per each input (fixed K-Factor of "1") and display frequency (rate per second) of incoming signal. (See TEST MODE for more information).

COMMUNICATION FOR 16 POINT

When 16-Point option is supplied with either RS232 or RS422 option, data can be read and changed as explained under Communication Section of the manual.

Codes to address 16-point data: (F=frequency; K=K-Factor; A to P = Point number 1 to 16)

FA = Frequency for A (Point 1)
KA = K-Factor for A (Point 1)
FB = Frequency for B (Point 2)
KB = K-Factor for B (Point 2)
- - = (Use of letters A to P for Points 1 to 16)
FP = Frequency for P (Point 16)
KP = K-Factor for P (Point 16)

To request a transmit of data, send a code for information desired. To change data, send the desired address code followed by a space and the new number desired.

Sample Code request and response:

Transmit from terminal

(S) = Space

Example A:

D13(S) (unit #13 activated)
FA(S)0(S)KA(S)123 (ENTER)
(Frequency for A (Point 1) is set to 0, K-Factor for A (Point 1) is set to 123)

Example B:

D11(S) (unit #11 is activated)
FC(S)500(S)KC(S)305(S)
FC(S)KC(S)(ENTER)
(Frequency for C (Point 3) is set to 500, K-Factor for C (Point 3) is set to 305,
Frequency of C (Point 3) is sent, K-Factor of C (Point 3) is sent.

CAUTION:

1) Frequency speed must increase with ascending point numbers. A bad sequence can be entered over the serial part. Unit will use calculated K-Factor based on first frequency match found, which may be wrong. Check by requesting a transmit of all frequency points used: FA FB FC FD to F_ to insure ascending sequence is entered or enter "POINT 00" on front keypad and unit displays "BAD SEQ" if there are errors.

2) After device is activated, there must be a delay to allow "Device #--" to be transmitted by the device before new commands are sent to the unit.

IRREGULAR SHAPE VESSEL APPLICATION NOTE: MEASURE VOLUME IN IRREGULAR SHAPED VESSELS WITH 16-POINT LINEARIZATION OPTION.

In the past it was difficult to calculate the volume of liquid and set up the equation or computer model to display the volume in containers with odd shapes. It usually required that a special electronic memory be made for each container.

The "16-Point" option allows a simple way to program the unit to display correct volume with resolution to 10,000 parts. all that is needed is the analog signal from a weight or level transducer (4 to 20 or 0 to 20mA, 0 to 5, 1 to 5, 0 to 10 VDC).

The easiest way to set the 16 points is to use the "Test" mode while filling the vessel. In this "Test" mode the unit converts the analog signal to a 1 to 10,000 base frequency reading.

Record the "Test" frequency reading in a column next to actual amount put into the vessel. Choose 16 points where there is a significant ratio change between the frequency reading and the actual volume. Divide the "Test" frequency by the actual volume to determine the the point K-Factor to be entered with the "test" frequency. Simply key in these point frequencies and K-Factors in order of ascending frequencies. Volumes between the 16 points entered will be interpolated from a K-Factor line slope generated from the closest 2 points entered.

Once the "16-Point" frequencies and K-Factors are entered, set the unit to "Second" reading of rate to display actual volume in the vessel. Disregard the counter readings.

Two separate control relays can be set to activate at different volume for monitoring or dispensing applications.

An optional 4 to 20mA output of the corrected volume can be supplied to drive a strip chart recorder, remote meter or other equipment.

CONCLUSION

This manual has attempted to cover all aspects of operation of the unit. It is written to cover most anticipated problems and misunderstandings. if some questions still arise or you feel some improvements can be made to this manual, please feel free to contact your local representative.

We hope you will be pleased with our product. If you have any questions concerning our warranty, repair, modification or returned goods process, please contact your local distributor.

